



VT500WHB

50GHz H-Plane Radius Bend Waveguide

Description

Bend waveguide can be made with many flange types. The available materials include OFHC copper, bronze, aluminum, silver and stainless steel. Basic styles in bend include miter and radius 90° bends, acute and obtuse E-plane and H-plane bends in angles from 30° to 180° .

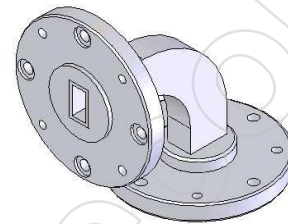

Specifications

MODEL NO	VT500WHB
FREQ RANGE (GHz)	39.2-59.6
VSWR	1.15
INSERTION LOSS (dB) Max	0.2
RETURN LOSS (dB)	23
HANDLING POWER (MW)	0.023
OPERATION TEMP (°C)	-40~+70
SIZE H*W*L (mm)	25*25*10
FLANGE TYPE	FUGP
WAVEGUIDE TYPE	WR18

Outline Drawings

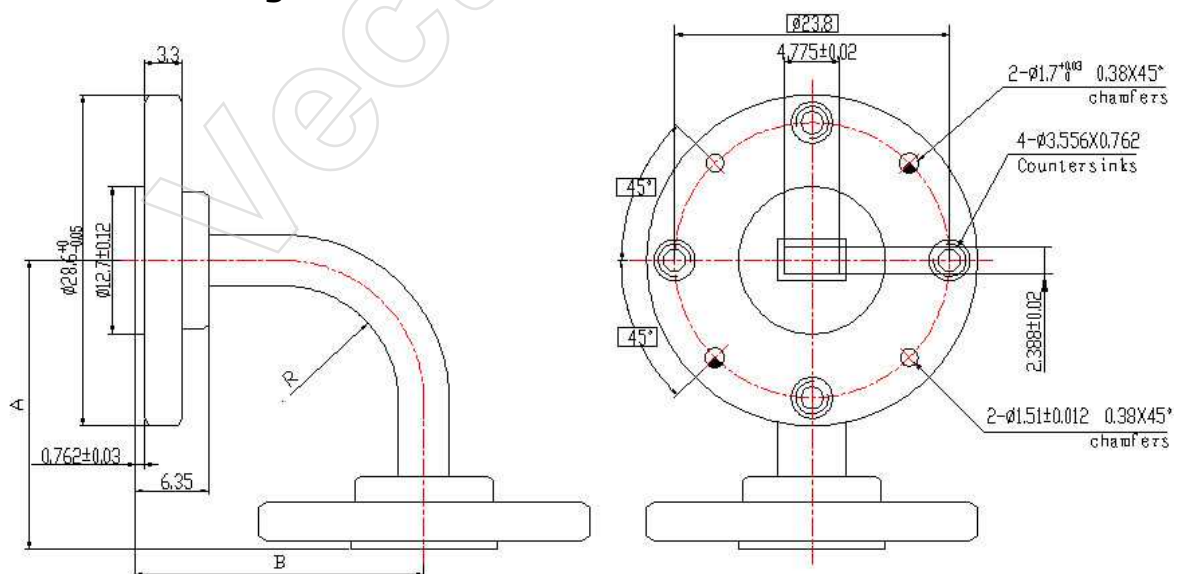

Flange Types

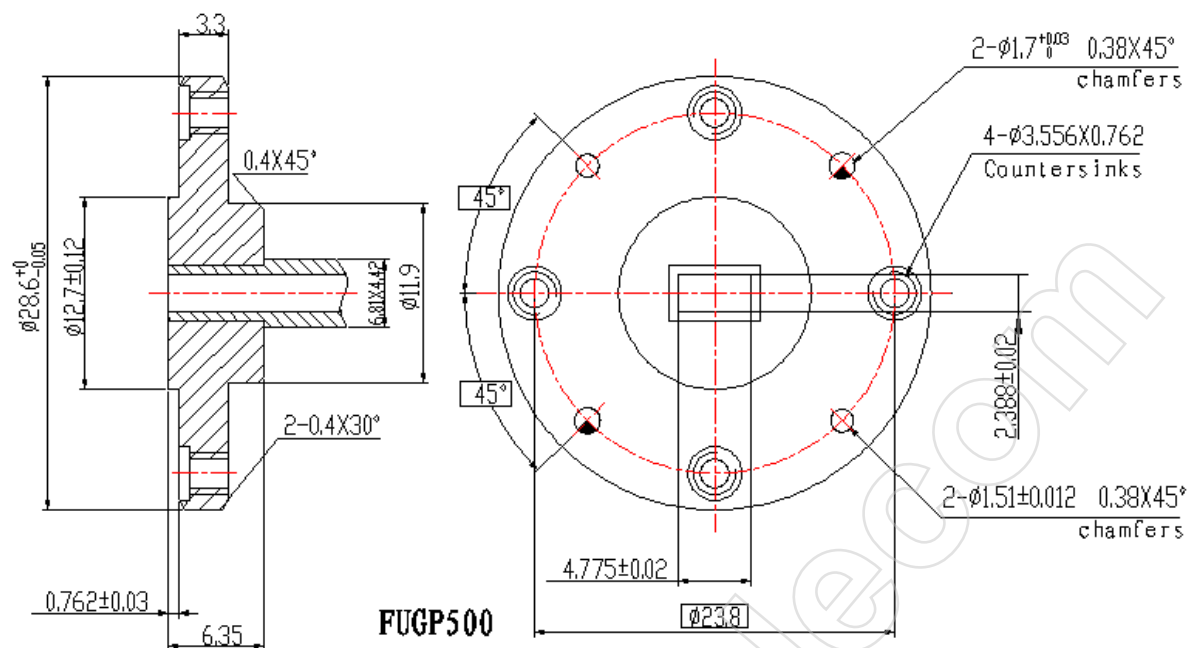

*Please refer to the Technical Reference section for more flange types/connectors details. The outline drawings shown are standard versions. Please contact us for your specific requirements.



Revision History

Date	Revision	Changes
01-Jul-2006	1	First release

Vector Telecom



Information furnished is believed to be accurate and reliable. However, Vector Telecom assumes no responsibility for the consequences of use of such information nor for any infringement of patents or other rights of third parties which may result from its use. No license is granted by implication or otherwise under any patent or patent rights of Vector Telecom. Specifications mentioned in this publication are subject to change without notice. This publication supersedes and replaces all information previously supplied. Vector Telecom products are not authorized for use as critical components in life support devices or systems without express written approval of Vector Telecom.

The Vector Telecom logo is a registered trademark of Vector Telecom Pty Ltd.

© 2006 Vector Telecom Pty Ltd - All rights reserved

Email: sales@vectortele.com

www.vectortele.com

