

Standard Gain Horn Antenna

Part No: VT8SGAH10NK

1.0	Mechanical Specifications	
1.1	Waveguide type	WR1150
1.2	Connector type	N-Female
1.3	Material	Aluminum
1.4	Inside finish	Chromate conversion
1.5	Outside finish	Anticorrosion grey paint
2.0	Electrical Specifications	
2.1	Frequency Range	0.64-0.98 GHz
2.2	VSWR (Max)	1.50
2.3	Gain (Avg)	10 dB
3.0	Outline Drawings	
		

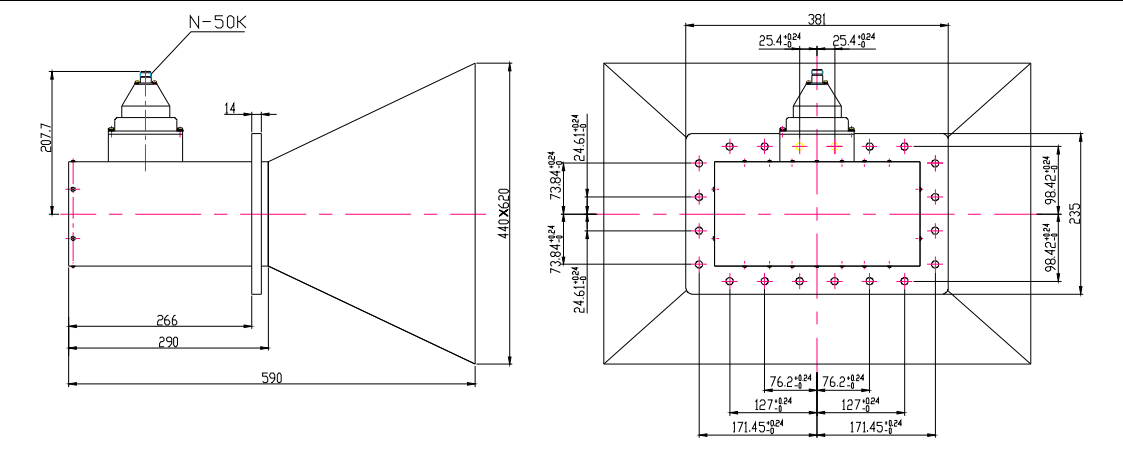

Revision History

Date	Revision	Changes
05-Mar-2006	1	First release

Information furnished is believed to be accurate and reliable. However, Vector Telecom assumes no responsibility for the consequences of use of such information nor for any infringement of patents or other rights of third parties which may result from its use. No license is granted by implication or otherwise under any patent or patent rights of Vector Telecom. Specifications mentioned in this publication are subject to change without notice. This publication supersedes and replaces all information previously supplied. Vector Telecom products are not authorized for use as critical components in life support devices or systems without express written approval of Vector Telecom.

The Vector Telecom logo is a registered trademark of Vector Telecom Pty Ltd.

© 2006 Vector Telecom Pty Ltd - All rights reserved

Email: sales@vectortele.com

www.vectortele.com

Vector Telecom Pty Ltd

Level 40, 140 William Street, Melbourne VIC 3000, Australia
Tel: +61 3 9607 8357 - Fax: +61 3 9607 8282 - www.vectortele.com