

## Waveguide to Coaxial Adapter 11.9-18GHz



### Features

- Full band operation
- Low VSWR
- Rugged mechanical configuration

### Typical Applications

- Transceivers
- Test setups
- Instrumentation
- Subsystems

### Electrical Specifications, TA=25°C

| Parameters    | Min  | Typ | Max  | Units |
|---------------|------|-----|------|-------|
| FREQ RANGE    | 11.9 |     | 18   | GHz   |
| VSWR          |      |     | 1.25 |       |
| Waveguide     | WR62 |     |      |       |
| Average Power |      |     |      | (W)   |

### Reliability Test Matrix

| Item                             | Standard      | Description   |
|----------------------------------|---------------|---|
| Operation Temperature            | MIL-STD-39016 | -45°C~+85°C   |
| Storage Temperature              |               | -55°C~+125°C  |
| Thermal Shock                    |               | 1 Hour. -45°C; 1 Hour +85°C, 5 Cycles   |
| Random Vibration                 |               | acceleration Spectrum Density 6 (m/s), Total Root mean square root 92.6   |
| Electrical & Temperature Burn In |               | Temperature +85°C 72 Hours  |
| Shocking                         |               | 1.Weight>20g, 50g half Sine wave for 11ms, Speed variation 3.44m/s<br>2.Weight≤20g, 100g Half Sine wave for 6ms, Speed variation 3.75m/s<br>3.6 Shocking Direction, 3 times each direction. Total 18 times. |
| Altitude                         |               | Standard Part: 30,000 Ft (Epoxy Sealed Controlled Environment)<br>Hermetically Sealed Part (Optional) 60,000 Ft 1.0 PSI min   |
| Hermetical Seal(Optional)        | MIL-STD-883   | MIL-STD-883(For Hermetical Seal Unit Only)  |

**VSWR:**

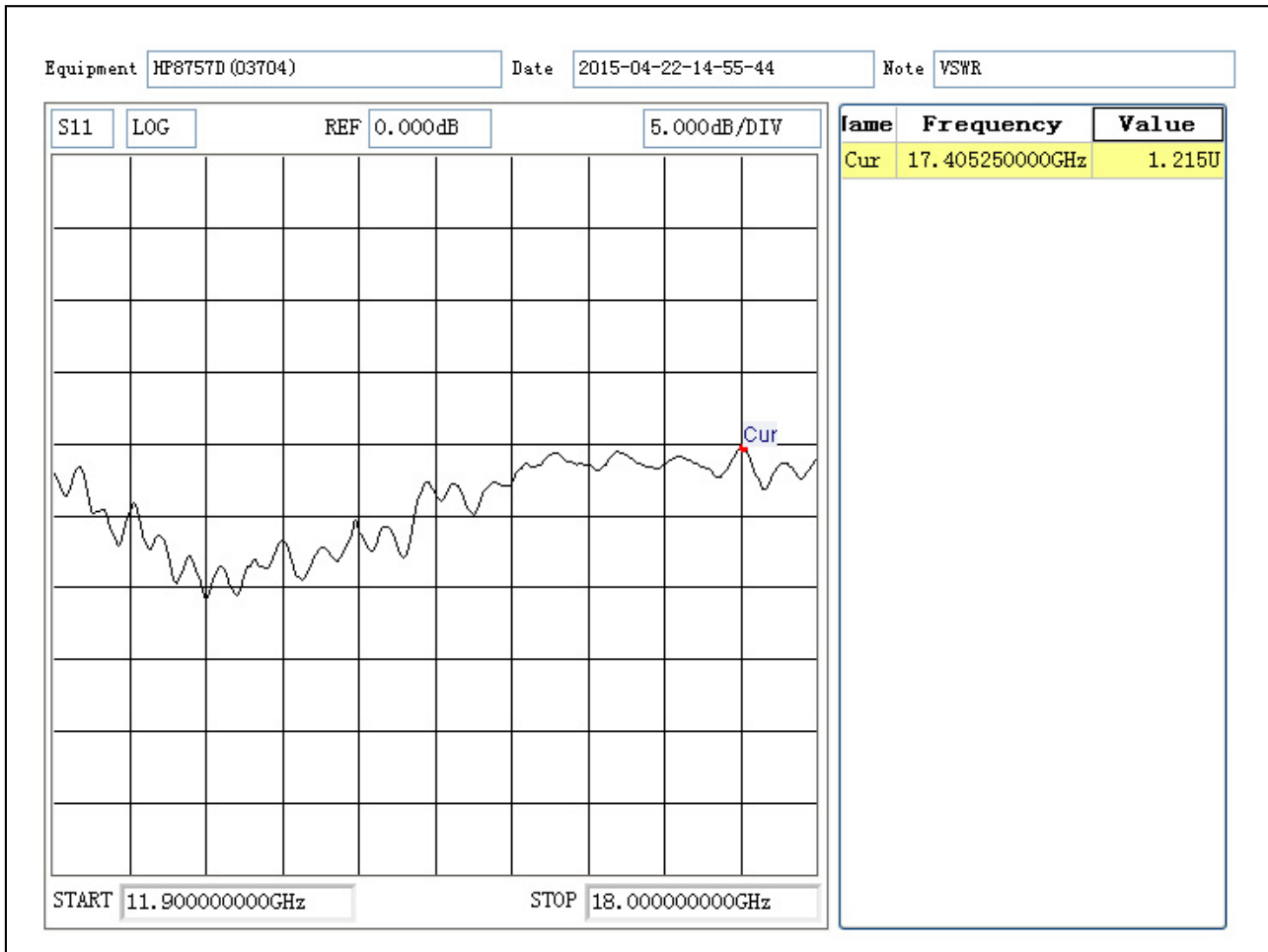

**Outline Drawing:**

All Dimensions in mm [inches]

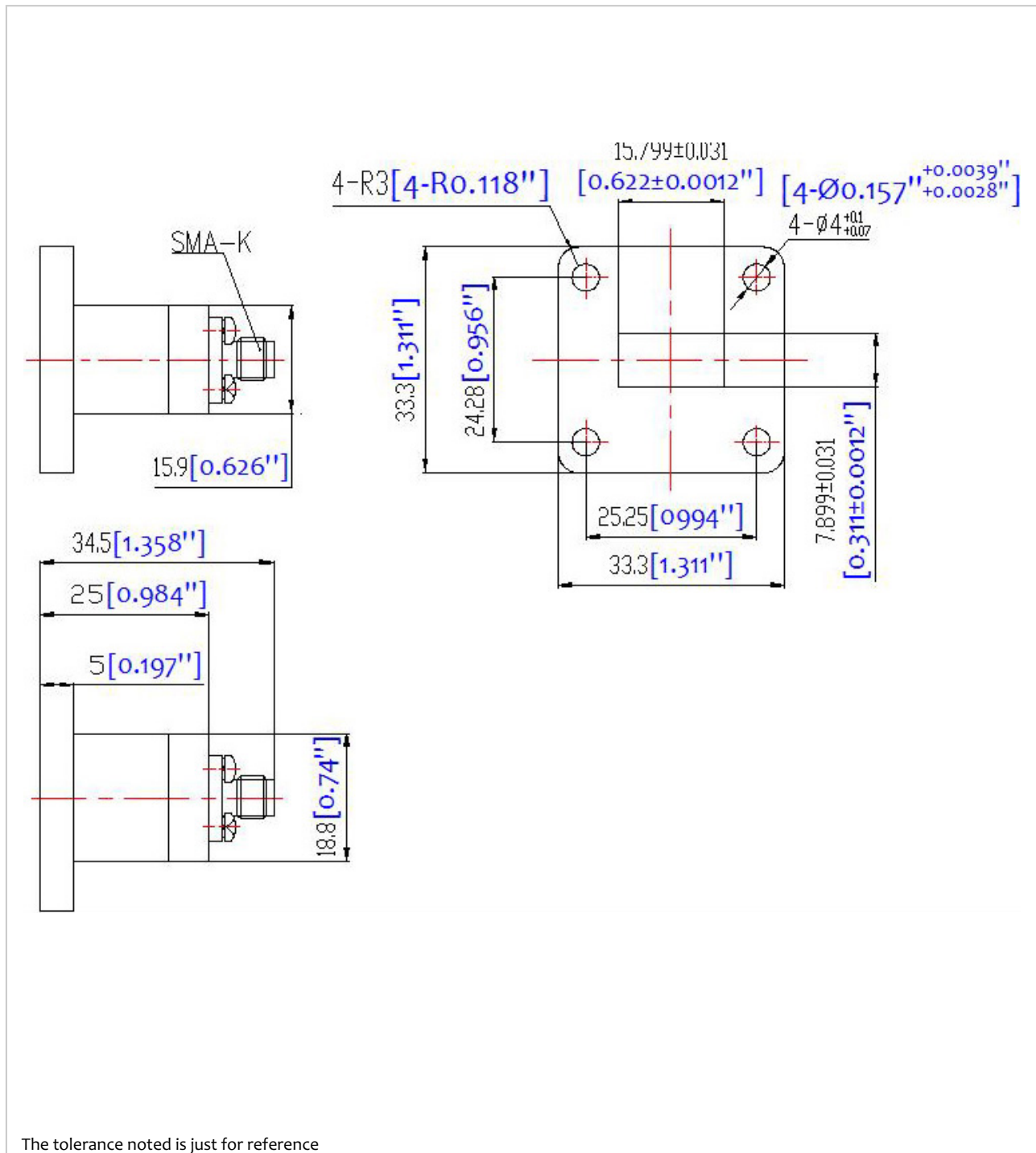

**Important Notice**

The information contained herein is believed to be reliable. RF-Lambda makes no warranties regarding the information contained herein. RF-Lambda assumes no responsibility or liability whatsoever for any of the information contained herein. RF-Lambda assumes no responsibility or liability whatsoever for the use of the information contained herein. The information contained herein is provided "AS IS, WHERE IS" and with all faults, and the entire risk associated with such information is entirely with the user. All information contained herein is subject to change without notice. Customers should obtain and verify the latest relevant information before placing orders for RF-Lambda products. The information contained herein or any use of such information does not grant, explicitly or implicitly, to any party any patent rights, licenses, or any other intellectual property rights, whether with regard to such information itself or anything described by such information. RF-Lambda products are not warranted or authorized for use as critical components in medical, life-saving, or life sustaining applications, or other applications where a failure would reasonably be expected to cause severe personal injury or death.